

Preferred fields of application:

The single acting telescope cylinders are mainly used as tilting cylinders for agricultural trailers. It is necessary to use a stroke limiting valve to prevent the cylinder from reaching the enposition under pressure. Maximum tilting angle is 30°

Principle of konstruktion:

The specified types of hydraulic telescope cylinders are based on the construction principle of plunger cylinders. Tilting bolts with a gimblar are fixed on the ground tube. A bore for mounting is forseen on the end of the smallest rod. The stroke of the rod is limited by retaining rings. The next wiping, sealing and guiding system guarantees less friction and an outstanding service life.

Maximum operating speed:

Up to 0,1 m/s

Sealing elements:

Polyurethan

Temperature range:

min. -10 ° Celsius
max + 80 ° Celsius.

Hydraulic pressure medium:

Standard mineral oils, biological oils (only after realisation by WEBER-HYDRAULIK)

Nominal pressure:

Working pressure 200 bar.
Test pressure 220 bar.

Permissible pressure force:

Permissible pressure force equals the maximum load of gimbal and must not be exceeded (Page 5)

Rod specification:

the single rod-stages are chrome-plated

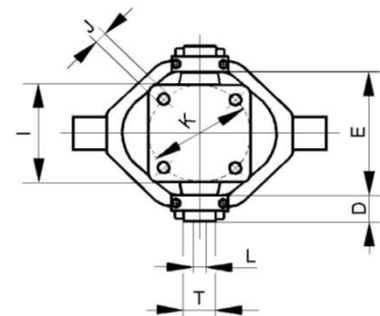
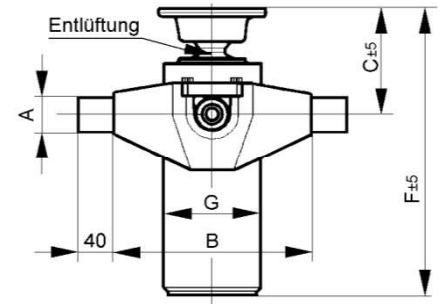
Advantages:

Certificate according to ISO 9001, surface primer coated, rod-stages chrome plated, Entlüftungsschraube ab Kolbendurchmesser 75 mm aufwärts.

Type: TZE 4P ...	stroke in mm ± 25 mm	Lifting power									Dimensions														
		Extensions									Gimbal				Cylinder										
		1,6 t	3,2 t	5,7 t	8,8 t	12,7 t	17,3 t	22,6 t	30,8 t	40,2 t	Gimbal Nr.	max. load in t	A Ø ±1,5 mm	B in mm	C in mm	D in mm	E in mm ± 2	F in mm	G Ø	I in mm	J Ø ± 0,5	K Ø ± 0,4	L	T Ø - 2	kg weight
32	45	60	75	90	105	120	140	160	3	6	40	230	170	23	127	421	95	95	13,5	100	M16x1,5	40	19,3	3,0	1810170
3210	1000								3	6	40	230	170	23	127	506	95	95	13,5	100	M16x1,5	40	23,0	4,0	1809458
3213	1350								4	8	40	230	170	38	141	421	110	95	13,5	100	M16x1,5	40	19,8	4,6	1809490
4510	1000								4	8	40	230	170	38	141	506	110	95	13,5	100	M16x1,5	40	34,4	6,1	1809512
4513	1350								4	8	40	230	180	38	155	517	125	125	14,5	125	M16x1,5	40	44,1	8,8	1809571
6013	1350								4	8	40	230	180	38	155	517	125	125	14,5	125	M16x1,5	40	49,0	10,4	1809598
6016	1600								4	8	40	230	180	38	155	517	125	125	14,5	125	M16x1,5	40	53,7	11,9	1810162
6019	1850								4	8	40	230	180	38	155	517	125	125	14,5	125	M16x1,5	40	53,7	11,9	1810162
7513	1350								5	12	45	230	180	38	169	517	145	125	14,5	125	M22x1,5	40	48,0	13,1	1809636
7516	1600								5	12	45	230	180	38	169	517	145	125	14,5	125	M22x1,5	40	53,0	15,4	1809652
7519	1850								5	12	45	230	180	38	169	517	145	125	14,5	125	M22x1,5	40	58,3	17,8	1810146
7524	2400								5	12	45	230	180	38	169	789	145	125	14,5	125	M22x1,5	40	69,2	22,9	1809717
9016	1600								6	16	45	280	180	40	189	581	165	125	14,5	125	M22x1,5	40	72,3	20,9	1809733
9019	1850								6	16	45	280	180	40	189	644	165	125	14,5	125	M22x1,5	40	78,5	24,1	1809750
9021	2150								6	16	45	280	180	40	189	724	165	125	14,5	125	M22x1,5	40	87,1	27,7	1810154
9024	2400								6	16	45	280	180	40	189	789	165	125	14,5	125	M22x1,5	40	91,7	31,0	1809792

Grey marked types only after prior consultation referring minimum quantity and lead time