

Preferred fields of application:

The single acting telescope cylinders are mainly used as tilting cylinders for agricultural trailers. It is necessary to use a stroke limiting valve to prevent the cylinder from reaching the enposition under pressure. Maximum tilting angle is 30°

Principle of konstruktion:

The specified types of hydraulic telescope cylinders are based on the construction principle of plunger cylinders. Tilting bolts with a gimblar are fixed on the ground tube. A bore for mounting is forseen on the end of the smallest rod. The stroke of the rod ids limited by retaining rings. The nex wiping, sealing and guiding system guarantees less friction an an outstanding service life.

Maximum operating speed:

Up to 0,1 m/s

Sealing elements:

Polyurethan

Temperature range:

min. -10 ° Celsius
max + 80 ° Celsius.

Hydraulic pressure medium:

Standard mineral oils, biological oils (only after reales by WEBER-HYDRAULIK)

Nominal pressure:

Working pressure 200 bar.
Test pressure 220 bar.

Permissible pressure force:

Permissible pressure force equalnt maximum load of gimbal and must not be exceeded (Page 5)

Rod specification:

the single rod-stages are chrome-plated

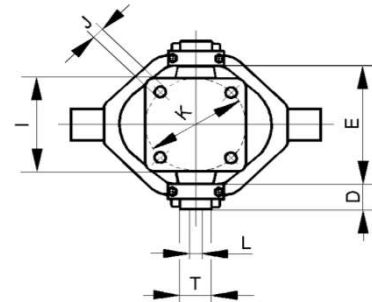
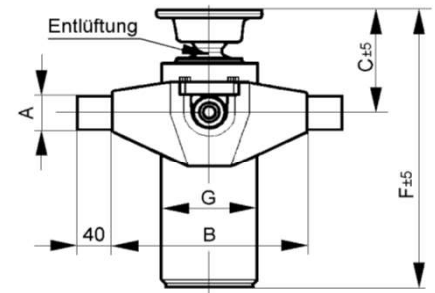
Advantages:

Certificate according to ISO 9001, surface primer coated, rod-satges chrome plated, Entlüftungsschraube ab Kolbendurchmesser 75 mm aufwärts.

Type: TZE 3P ...	stroke in mm ± 25 mm	Lifting power							Dimensions																
		Extensions							Gimbal					Cylinder											
		1,6 t	3,2 t	5,7 t	8,8 t	12,7 t	17,3 t	22,6 t	30,8 t	Gimbal Nr.	max. load in t	A Ø ±1,5 mm	B in mm	C in mm	D in mm	E in mm ± 2	F in mm	G Ø	I in mm	J Ø ± 0,5	K Ø ± 0,4	L	T Ø - 2	kg weigth	Oil volume in l
3208	760								3	6	40	230	170	23	127	408	80	95	13,5	100	M16x1,5	40	15,5	2,0	1808931
3210	1020								3	6	40	230	170	23	127	493	80	95	13,5	100	M16x1,5	40	18,1	2,6	1808974
4507	750								3	6	40	230	170	23	127	417	80	95	13,5	100	M16x1,5	40	19,8	2,7	1808990
4510	1000								3	6	40	230	170	23	127	503	95	95	13,5	100	M16x1,5	40	23,5	3,6	1809016
6010	1000								4	8	40	230	180	38	141	514	110	125	14,5	125	M16x1,5	40	37,2	5,4	1809032
6012	1200								4	8	40	230	180	38	141	578	110	125	14,5	125	M16x1,5	40	41,2	6,4	1809059
6014	1400								4	8	40	230	180	38	141	641	110	125	14,5	125	M16x1,5	40	45,1	7,4	1809075
6016	1600								4	8	40	230	180	38	141	641	110	125	14,5	125	M16x1,5	40	49,9	8,2	1810731
7512	1200								4	8	40	230	180	38	155	578	125	125	14,5	125	M16x1,5	40	39,5	10,4	1809113
7514	1400								4	8	40	230	180	38	155	641	125	125	14,5	125	M16x1,5	40	43,1	11,9	1809130
7516	1600								4	8	40	230	180	38	155	721	125	125	14,5	125	M16x1,5	40	47,8	13,9	1809172
7518	1800								4	8	40	230	180	38	155	786	125	125	14,5	125	M16x1,5	40	50,5	15,5	1809199
9014	1400								5	12	45	230	180	38	169	641	145	125	14,5	125	M22x1,5	40	54,4	16,2	1809237

Grey marked types only after prior consultation referring minimum quantity and lead time