

Stage diameters
129
110
91
72
53

front view cylinder

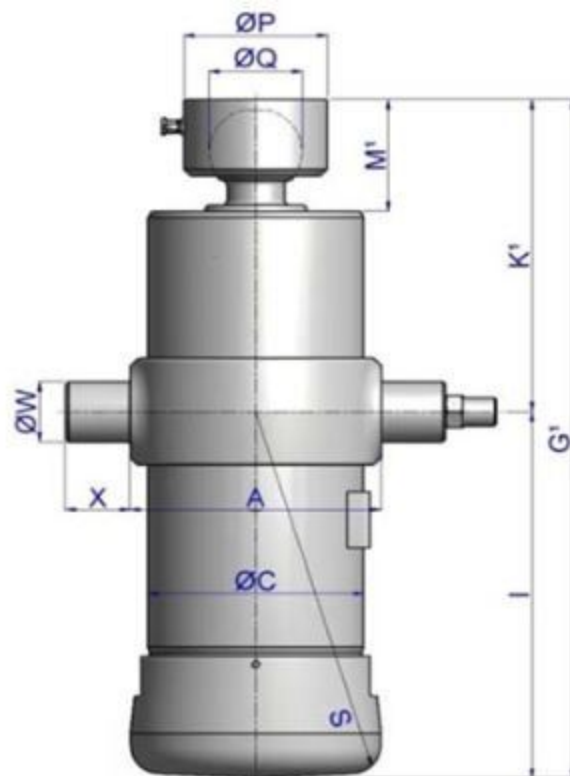

A	175
ØC	150
G¹	588
I	396
K¹	192
M¹	86
ØP	88
ØQ	53
S	403
ØW	45
X	45

¹including 20 mm pull-out [tol. -5; +30 mm]

specifications

total stroke ¹	1880 mm
dry weight cylinder only	66 kg
total volume	14.7 L
working volume	13.3 L
maximum pressure	220 bar
maximum pump flow	33 l/min
maximum allowable thrust first stage ³	15.0 ton
oil inlet	1/2" BSP