

Stage diameters
149
129
110
91
72

front view cylinder

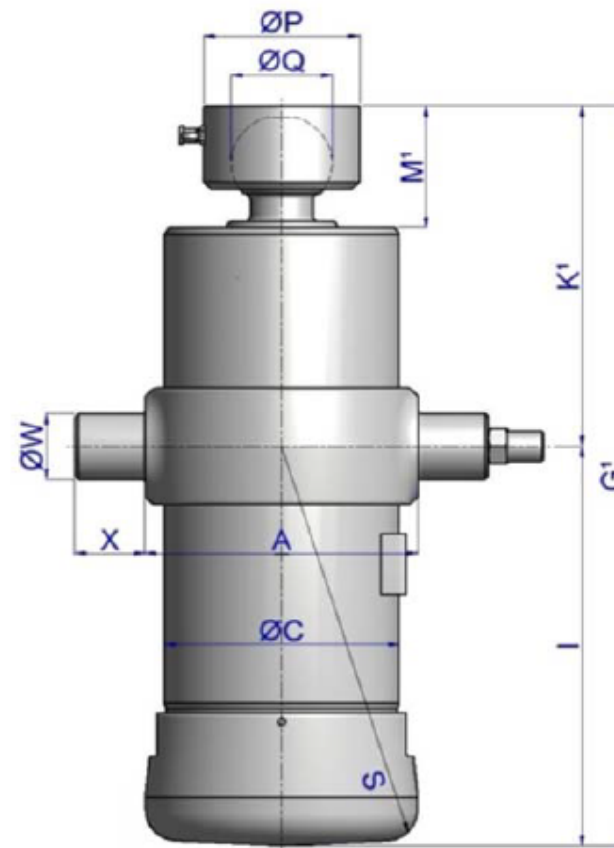

A	205
ØC	170
G ¹	739
I	481
K ¹	258
M ¹	99
ØP	100
ØQ	65
S	488
ØW	50
X	45

¹including 20 mm pull-out [tol. -5; +30 mm]

specifications

total stroke ¹	2480 mm
dry weight cylinder only	95 kg
total volume	27.4 L
working volume	25.1 L
maximum pressure	220 bar
maximum pump flow	61 l/min
maximum allowable thrust first stage ³	20.0 ton
oil inlet	3/4" BSP