

Stage
diameters

129
110
91
72
53

front view cylinder

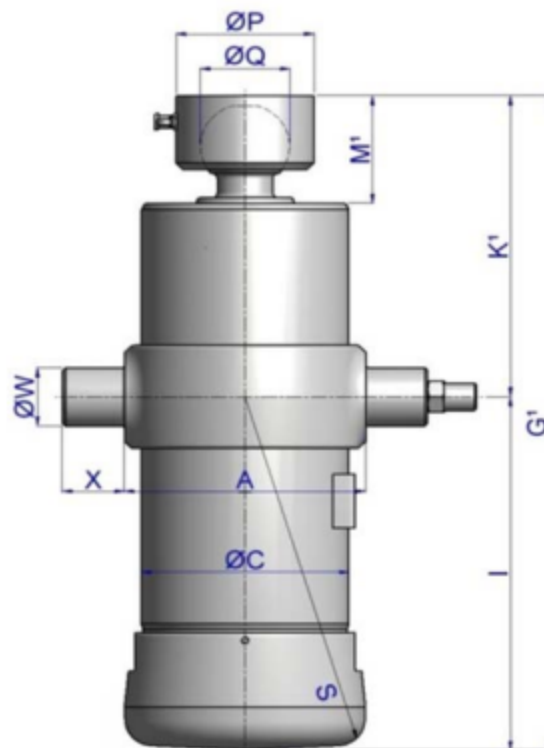

A	175
ØC	150
G ¹	508
I	316
K ¹	192
M ¹	86
ØP	88
ØQ	53
S	325
ØW	45
X	45

¹including 20 mm pull-out [tol. -5; +30 mm]

specifications

total stroke ¹	1480 mm
dry weight cylinder only	57 kg
total volume	11.6 L
working volume	10.5 L
maximum pressure	220 bar
maximum pump flow	33 l/min
maximum allowable thrust first stage ³	15.0 ton
oil inlet	1/2" BSP